

GRILL CABIN 4.5



PRODUCT DESCRIPTION

Amazing Grill Cabin 4.5 m² is designed for a family or a small circle of friends to have a good time, and it can be used in all weather conditions. As well as the cabin is a convenient option if you have little space in the garden. Grill Cabin made of quality materials is not only functional but also decorates the environment. A good selection of a cabin color can make a garden or a yard look exceptional.

High-quality materials ensure the longevity of the grill house and easy use. Cabin walls are made of rounded spruce boards. The roof is made of six elements, thus the system can withstand the considerable weight. Cabin roof is covered with bitumen shingles (different colors can be selected), and there are three opening double glazed windows. Besides that, the door is decorated with the original hexagonal window. You also will get 3 spruce benches inside the cabin by the walls. The floor is easily assembled from separate components. There is a convenient wood or charcoal-fired grill with a table around it inside the cabin. Above the grill, there is an adjustable chimney. Finally, the cabin is lockable and there is a small porch with a roof at the entrance.

From now you can order Factory Painted Grill Cabins!

The high-quality preservative finish is professionally spray applied in the factory to one side of the wood. The product is treated in your choice of color. You can choose two colors for one product: one for almost all product details and another for finishing details.



SPECIFICATION

| | |
|---------------------------|--------------------|
| People | 5-6 persons |
| Timber | Spruce |
| Shape | Hexagon |
| Room | 1 |
| Inside area | 4.5 m ² |
| Total height | 200 mm |
| Wall height | 1330 mm |
| Floor thickness | 18 mm |
| Wall thickness | 45 mm |
| External dimension | 2740 x 2373 mm |
| Door size | 782 x 1500 mm |
| Window size | 680 x 380 mm |

STANDARD SET

Wall, floor, roof panels;

Roof covered with bitumen shingles of your selected color;

Inside grill with the cooking platforms and a table around the grill;

Adjustable chimney;

3 double glass windows (all of them are opening);

Door with a lock and a hexagon window;

3 benches (with cushions) inside.

DELIVERY

Assembling time

6 hours

Size of pallets (LxWxH)

2.1 x 1.2 x 2.2 m

Weight

880 kg

Grill Cabin 4.5 m² is delivered to the customer fully complete, with detailed assembly instructions and drawings, and packed on a pallet (KIT).

- Size of pallet (L x W x H): 2.1 x 1.2 x 2.2 m.
- The standard grill is packed with the cabin together but we strongly recommend to choose packing on a separate pallet of size (L x W x H): 0.90 x 1.20 x 1.50 m.
- **"Viking" grill** is packed only on a separate pallet of size (L x W x H): 1.05 x 1.05 x 0.86 m.
- **"Luxury" grill** is packed only on a separate pallet of size (L x W x H): 0.90 x 1.20 x 1.25 m.
- **"Premium" grill** is packed only on a separate pallet of size (L x W x H): 0.90 x 1.20 x 1.25 m.

Please write a comment if you want the grill to be put in a box.

~ We pack all accessories on the same pallet if it is possible. Otherwise, all accessories will be packed on a separate pallet.

GRILL AND CHIMNEY SET



"Premium" 6-corner grill and chimney



"Viking" Grill and Chimney



Standard 6-corner Grill and Chimney



Luxury Grill and Chimney



Without Grill and Chimney

OPTIONS

AVAILABLE ROOF COLOR

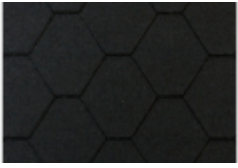

Black shingles

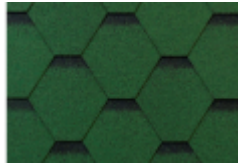

Green shingles



Red shingles

WALLS HEIGHT

- One extra board in wall (*the height of board - 145 mm*)
- Two extra boards in wall

ROOF PANEL WITH WINDOW FOR GRILL CABIN



BENCHES AND CUSHIONS:

- Benches + brown cushions;
- Benches + blue cushions;
- Without cushions;
- Without benches and cushions.



ACCESSORIES



Brown curtains set



Blue curtains set



Grill cover



Grill table safety fence*



Firewood ring



Drawer



Reindeer hides



Shelf for Grill cabin



Stainless steel door sill



Wooden dishes and flatware set**



Door stopper



Flower pot for Pavilion and Grill

* Only for Standard 6-corner grill and chimney set

**Available "Basic", "Optimal" or "Luxury" set.

DRAWINGS

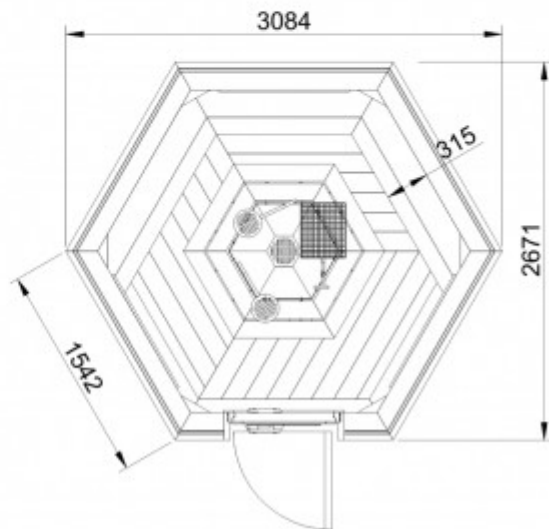
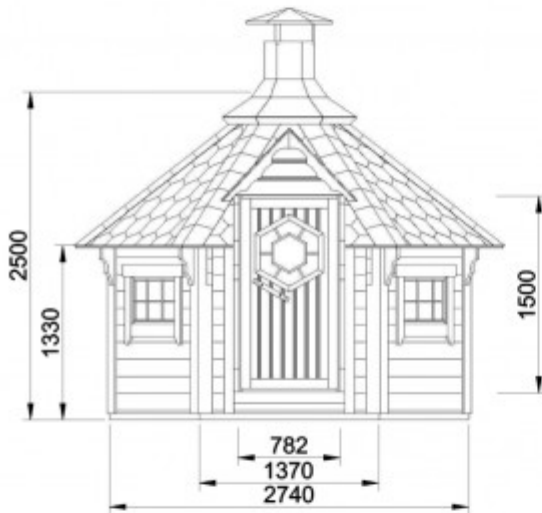
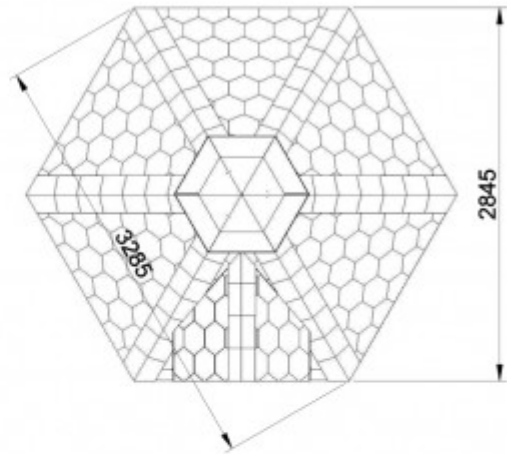

FOUNDATION

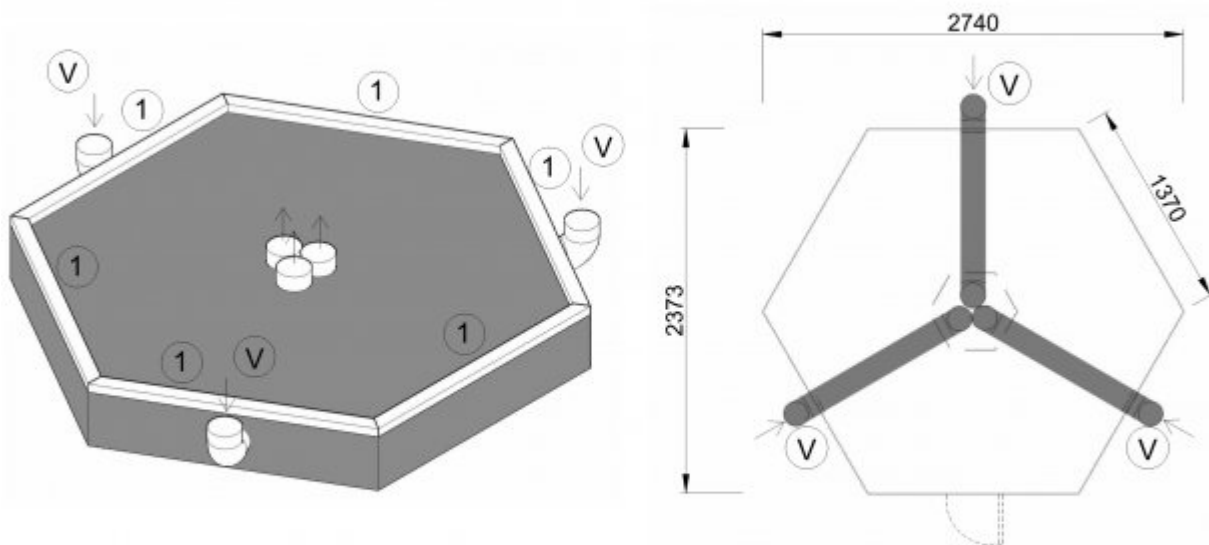

It is very important to have a proper base for your Grill Cabin. Therefore, we recommend following our sketches and consulting a qualified local builder or engineer. Making sure that the base for your product fits the location is of utmost importance.

Due to an improper base, the structure may crack. If the product is unevenly seated, the geometric shape of the building may change, which can result in the door/windows twisting, and/or gaps. In the worst-case scenario, the product may even collapse.

- Before building the base, make sure you take into account the landscape and the ground conditions on which the product will stand.
- The base under the product must be prepared specifically for the product.
- The base must be homogeneous, tight, and level.
- Make sure that the properties of the base do not change over time. We recommend making the base out of concrete and water-proofing it before installation.

If you do not follow recommendations for building the base, the product will lose its warranty!

PAINTING

COLOR CARD

EXTERIOR WOOD STAIN COLORS



Water-based, quick drying premium total protection for wood outside.
Thin layer varnish – 3 in 1: impregnation, primer, and varnish!

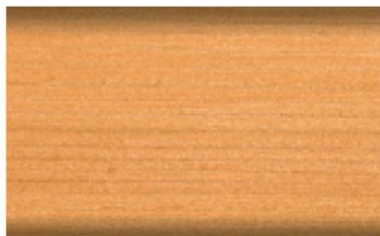

PINE / LARCH RC260

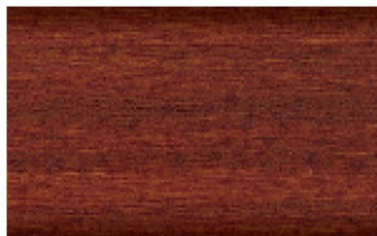

TEAK RC545

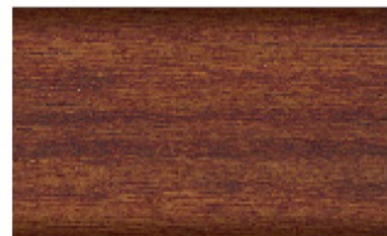

CHESTNUT RC555



FIR GREEN RC960

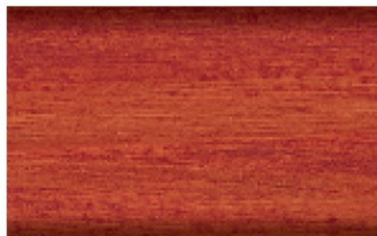

MAHAGONY RC565

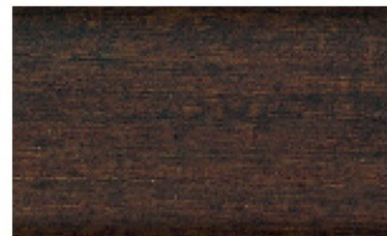

PALISANDER RC720



SILVER GREY RC970

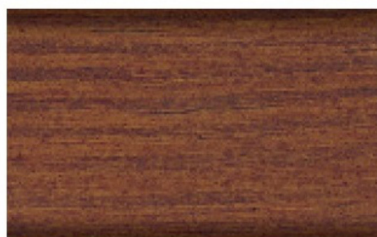

NUT WOOD RC660



PINE RC270

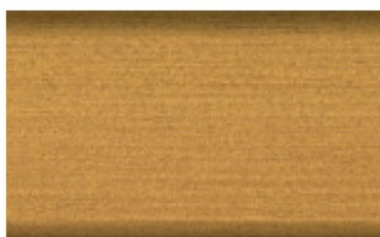

RUSTIC OAK RC360



LIGHT OAK RC365



HEMLOCK RC120



WHITE RC990

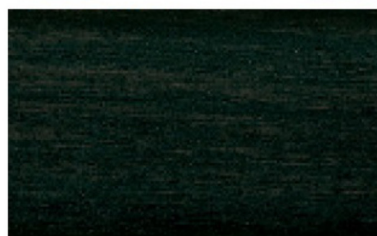

EBONY RC790

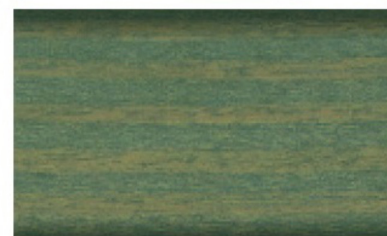

SALT GREEN RC965

PLEASE NOTE: The colors shown in the catalogue and website may not 100% match the color you will receive.
The color of the wood material affects the final color.

PAINTING

COLOR CARD

EXTERIOR WOOD PAINT COLORS

Weather protection, water-based paints. High-performance and environmentally friendly.

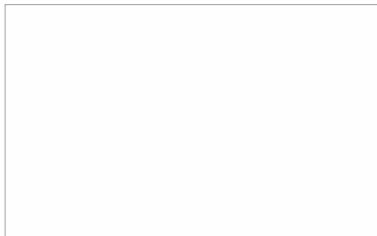

WHITE / RAL 9016



ANTRACITE GREY / RAL 7016

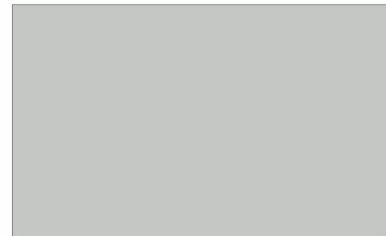

LIGHT GREY / RAL 7035



DUSTY GREY / RAL 7037

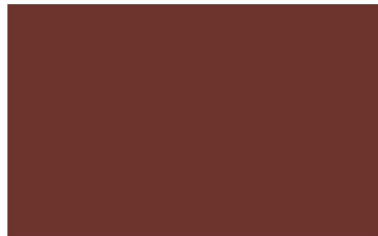

OXIDE RED / RAL 3009



JET BLACK / RAL 9005



MOSS GREEN / RAL 6005



AZURE BLUE / RAL 5009



GREY BROWN / RAL 8019



BROWN RED / RAL 3011

PLEASE NOTE: The colors shown in the catalogue and website may not 100% match the color you will receive. The color of the wood material affects the final color.

PAINTING

AUTOMATIC MACHINE SPRAY TECHNOLOGY

Benefits

One of the main and most obvious benefits of using a paint machine is the speed and flexibility at which we can suggest our painting service for all of our products. A spray paint machine can get the work done faster and more consistently than manually painting. While the machine works faster, it improving quality too – sprayers produce an even coat of paint, leaving a high-quality finish.

With our painting service from now, we can suggest to our client's maximum flexibility! Not assembled products as Grill cabins, Pavilions, Camping pods, and other products of any size you can order painted too!

PROFESSIONAL SPRAY

The high-quality preservative finish is professionally spray applied in the factory to one side of the wood. The product is treated in your choice of color. You can choose two colors for one product: one for almost all product details and another for finishing details.

STAIN | PAINT

Which type of painting should i Use?

Properly painting and impregnating is one of the most important things to consider when thinking about how to extend your product lifetime.

Paint and natural wood finish instantly spruce up the aesthetics of your product.

The decision you will need to make is if you want to use a water-based wood stain or paint. Both will offer you UV protection. The wood stains will allow the texture of the wood to show through and many are now available in a vast range of colors, however, paints will give you an intensive color, but will cover the grain and texture of the wood.

USAGE AND MAINTENANCE

USAGE.

- **The first time you'll use your Grill the surfaces of the new product that are in direct contact with the flames may create a smoky smell when heating up.** We advise to keep the door open during the first use and not to cook until the smell disappears.
- When burning wood we recommend to use Grill table metal safety fence.
- We suggest you to use only firewood or briquettes. Larger burning objects can be added later when the fire is burning well. We advise to use objects no larger than 300 mm.
- A sufficient flow of fresh air is the most essential aspect of smoke exhaustion. At least as much fresh air should come in as goes out with the smoke.
- If the Grill is generating a lot of smoke, open the door of the Grill Cabin and make sure that the wood is dry and without a bark. Put in additional dry wood if needed.
- Keep decorations away from your Grill. Hanging decorations look pretty, but provide fuel for a fire.
- Keep water nearby for flare-ups.
- **Keep a fire extinguisher within a couple steps of your Grill.** And KNOW HOW TO USE IT!
- **Don't leave a Grill unattended.** Don't allow kids or pets to play near the Grill. Never try to move hot Grill, and remember the Grill will stay hot for at least an hour after its use.
- Do not sleep in a Grill Cabin when the fire is on!
- Use protective gloves when handling hot cooking plates. **Never move or service an operating Grill.**
- Please note, that the metal Grill may have sharp edges and the steel parts of the Grill heats up when the fire is burning, therefore there is risk to harm or burn yourself.
- Remove ashes from the Grill after they have cooled down.
- Make sure you give yourself time to clean your Grill after each use in order to ensure maximum hygiene and proper functioning.

MAINTENANCE.

You should not forget that wood is a natural material, it changes and moves depending on weather conditions. Large and small cracks, color tone differences and other changes, as well as a changing structure of wood are not defects, but a result of wood growing and a feature of wood as a natural material. Natural wood (not impregnated) becomes grayish after being left untouched for a while, and can turn blue and become moldy. You should immediately process it with wood preservative to protect the wooden parts of our manufactured products.

We definitely recommend that you process the door and windows with a wood preservative, and do it on both sides (inside and outside), because the doors and windows can deform. Also, you should pre-treat the floor panels with a wood preservative, especially the bottom sides of the panels, to which you will no longer have access when the Cabin is assembled. Only this will prevent moisture penetration.

In general, we recommend for the conclusive finishing a weather protection paint that will protect wood from moisture and UV radiation after the Cabin is assembled. Consult a specialist regarding paints suitable for unprocessed softwood and follow the paint manufacturer's instructions. Your Grill Cabin service life will be much longer after it will be properly painted. **We recommend that you inspect your Cabin thoroughly once every six months.**

Customer should make sure that air circulation is working in winter as well. It means that air pipes are open all year around and that moisture gets out from the product (through chimney). Customer should also make sure that product's roof is not covered by snow. A layer of snow cannot be thicker than 20 cm on the roof and the flue should never be covered by snow or closed manually.



Misko 25, LT-85302 Venta, Lithuania
info@vikingindustrier.com